

氣霸牌嵌入式煮食爐使用說明書  
HIBACHI BUILT-IN GAS HOB OWNER'S MANUAL

MODEL  
型號 HY-9229 (香港煤氣 HK Town Gas)



如有任何爭議，氣霸爐具有限公司保留最終決定權。  
In case of disputes, the decision of Hibachi Gas Cooker Ltd. shall be final.

氣霸爐具有限公司  
Hibachi Gas Cooker Limited

電話Tel:(852)2300 1357(3Lines) 傳真Fax:(852)2782 6395  
[www.hibachi.hk](http://www.hibachi.hk)

**各部分名稱** Parts Identification

- |                              |                             |                                |
|------------------------------|-----------------------------|--------------------------------|
| ① Ignition Plug (點火針)        | ② Ignitor (脈衝點火器)           | ③ High Voltage Leadwire (高壓導線) |
| ④ Air Shutter (調風板)          | ⑤ Injector (噴嘴)             | ⑥ Trivet (爐架)                  |
| ⑦ Drip Plate (爐碟)            | ⑧ Battery Compartment (電池盒) | ⑨ Gas Valve (閥體)               |
| ⑩ Gas Pipe (氣管)              | ⑪ Thermocouple (熱電偶)        | ⑫ Gas Inlet (進氣接嘴)             |
| ⑬ Burner (爐頭)                | ⑭ Top Panel (面板)            | ⑮ Inner Burner Cap (小銅蓋)       |
| ⑯ Flame Controller Knob (旋鈕) | ⑰ Large Burner Cap (大銅蓋)    |                                |

**HY-9229**

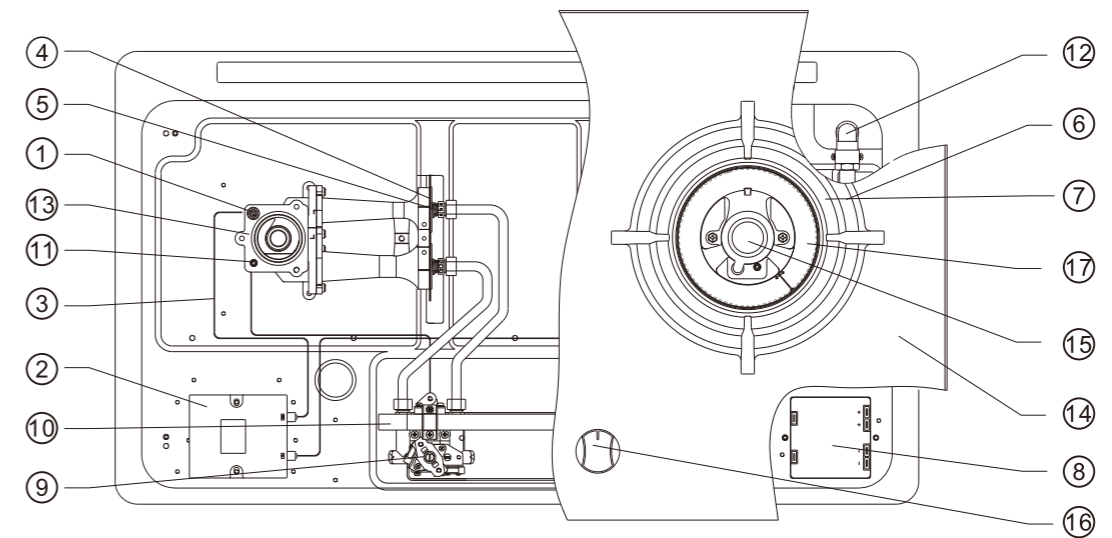

## 警告 WARNING

- 1、注意！根據香港氣體安全條例，任何氣體裝置工程，包括爐具和接駁喉管的安裝，必須由註冊氣體裝置技工執行，而該技工已於相關的氣體工程類別註冊及受聘於註冊氣體工程承辦商。  
Attention! According to the Gas Safety Ordinance of Hong Kong, any gas installation works including the installation of appliances and connection tubing, must be undertaken by registered gas installers who are registered for that appropriate classes and be employed by registered gas contractors.
- 2、此爐具的煤氣嵌入式型號不需安裝外置氣體穩壓器。(圖9)  
The Town gas model of this built-in gas hob, external gas governor is not required. (Fig.9)
- 3、禁止使用錫紙爐碟  
Never use aluminum tray.
- 4、用爐時小心燙手  
Mind your hand when use the built-in gas hob.
- 5、使用認可印有機電工程署批准標記(例如:機電工程署批准EMSD APPROVAL GTXXXX)的氣體接駁喉管連接爐具，或使用機電工程署接納的其他恰當方法。  
Use approved gas tubing bearing EMSD approval marking (such as: 機電工程署批准EMSD APPROVAL GTXXXX) for connection to appliances, or other appropriate methods accepted by EMSD.
- 6、當在灶櫃面安裝嵌入式氣體煮食爐時，灶櫃應設有透氣設施，以確保煮食爐在使用時操作正常。  
When installing built-in gas hob on top of stove cabinet, please check that there is provision for ventilation at the cabinet to ensure proper operation of the built-in gas hob.
- 7、不應將易燃物料、噴霧及壓縮容器放置在灶櫃內。  
Do not store any flammable materials, sprays or pressurized containers inside the stove cabinet.
- 8、此煮食爐的面板是用強化玻璃製造，較一般玻璃安全。唯使用嵌入式玻璃面板煮食爐時還須注意以下事項，以避免玻璃面板爆裂。
  - a. 經常清潔爐頭組件以保持火蓋焰孔暢通，如滾瀉食物及汁液，應在爐頭組件冷卻後盡快作出妥善清理。
  - b. 如煮食爐出現不尋常聲音，應立即停用並安排氣體供應公司或爐具進口商檢查。
  - c. 切勿使用過大的器皿煮食。
  - d. 切勿以硬物撞擊或將重物放置於玻璃面板。

The top panel of this built-in gas hob is made of tempered glass which is safer than normal glass for this application. However, the following safety precautions for using built-in gas hob with glass top panel should also be noted in order to prevent the glass top panel from breaking :

  - a. Clean the burner assembly frequently to maintain a clear gas passage on the flame distributor.  
Clean and tidy up the flame distributor after spillage of food and liquid once the burner assembly cooled down.
  - b. Turn off the built-in gas hob immediately if abnormal noise propagates from the built-in gas hob and contact gas supply company or built-in gas hob importer for inspection.
  - c. Do not use oversized utensils for cooking.
  - d. Do not impact the glass surface with hard objects or place heavy objects on the glass surface.
- 9、建議可使用之最大尺寸及最重器皿：直徑30cm，重量10kg。  
The suggestion of the dimension and the weight of the utensil: max diameter 30cm, max weight 10kg.



External Gas Governor Not Required  
不需安裝外置穩壓器  
(圖9) (Fig.9)

## 謝謝您的首選 THANK YOU FOR CHOOSING OUR PRODUCTS

氣霸牌氣體爐具產品系列（香港石油氣 / 香港煤氣）是一臺經過精心設計，符合嚴格品質要求的產品。為使您的爐具能保持在最佳的使用狀態，請詳細閱讀此說明書後正確使用爐具並妥為保存。

HIBACHI gas appliance is a series of gas (HK LP Gas / HK Town Gas) stoves specially designed for nowadays environment and meets the quality requirements. To ensure that our gas appliance is being used efficiently and under best conditions, we recommend users to read through this operation and maintenance manual before use.

## 功能特點 FEATURES

- 1、爐殼採用最先進設計。
  - 2、面板採用進口工藝製作的強化玻璃製造，經久耐用，易清洗。
  - 3、高熱效率的燃燒設計，節能效果更明顯。
  - 4、脈衝點火、五段安全開關、多段火力，並可隨意調整火力以適應各種烹調製作的需要。
  - 5、構造堅固耐用，安裝容易。
1. High quality casing design.
  2. The surface plate are using tempered glass. It is very easy to clean.
  3. The combustion design is using high thermal efficiency design.
  4. All our products are using electric pulse type ignition with several electric pulse. Flames can be easily adjusted suiting all kinds of cooking.
  5. Robust construction and easy installation.

## 安裝需知 INSTALLATION PROCEDURE

此爐具採用先進式設計

- 1、安裝嵌入式煮食爐的櫥櫃必須留有與空氣流通的間隙，且開孔尺寸不小於100×100毫米（如圖2所示）。
- 2、將樣板覆蓋在爐檯上，開出爐檯的孔後，放入爐具（如圖1所示）。

1. Make sure there is an air gap opening not less than 100×100mm for installation of built-in gas hob.(Fig.2)
2. Put the mounting plate on to the kitchen bench. Make a hole on the bench. Insert the stove.(Fig.1)

HY-9229 開孔尺寸 (670×350)mm

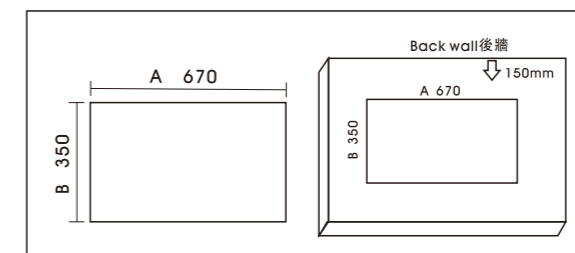

(圖1) (Fig.1)

爐具需與牆壁保持足夠距離。(如圖2所示)

Allow minimum required space from walls and ceiling.(Fig.2)

如沒有保持足夠距離，可能會導致火警。

If the minimum distances from walls and ceiling are not kept, a fire may be caused.

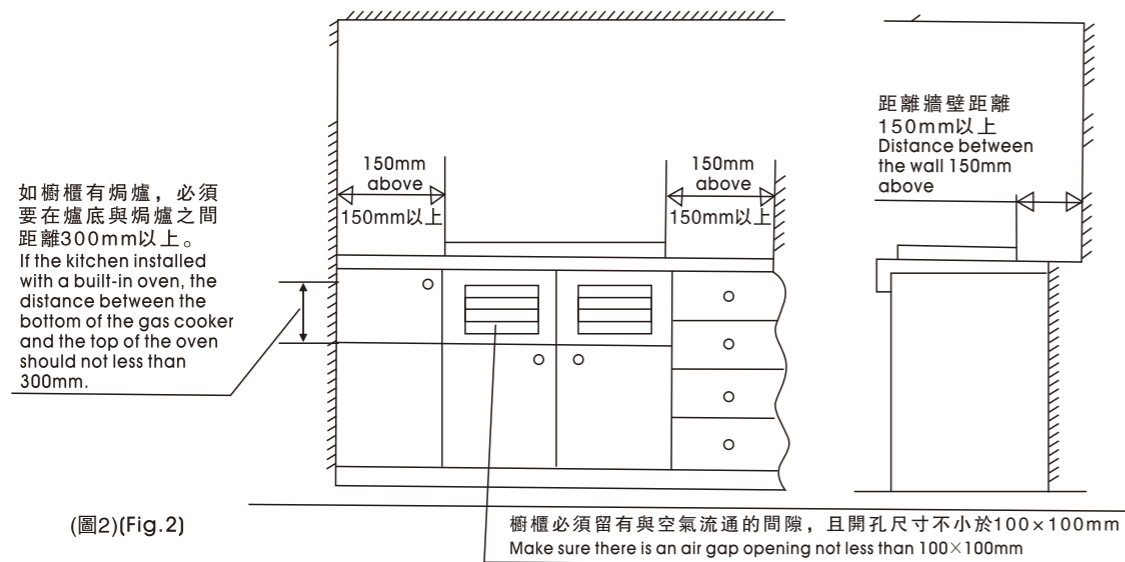

(圖2)(Fig.2)

## 安裝、維修 INSTALLATION AND MAINTENANCE

- 1、接駁氣喉前請先確認氣體種類是否正確。
  - 2、根據香港氣體安全條例，任何氣體裝置工程，包括爐具和接駁喉管的安裝，必須由註冊氣體裝置技工執行，該技工已於相關的氣體工程類別註冊及受聘於註冊氣體工程承辦商。
  - 3、如需維修或更換零件，請與代理商或經銷商聯絡，使用原廠配件。
  - 4、喉管與爐具接駁妥當後，必須用儀器測試，防止洩漏。
  - 5、如因人為損壞、錯誤或不恰當使用爐具而導致之損失，爐具進口商一律拒絕負責。
1. Before connecting the gas tubing please make sure the correct type of gas is being used.
  2. According to the Gas Safety Ordinance of Hong Kong, any gas installation works including the installation of appliances and connection tubing, must be undertaken by registered gas installers who are registered for that appropriate classes and be employed by registered gas contractors.
  3. If users want to have parts replaced or repaired, please contact our local agent for arrangement.
  4. After installation of built-in gas hob and connecting to the flexible gas tubing, a leakage test must be conducted using suitable instrument.
  5. Built-in gas hob manufacturer and local agent are not liable for any loss resulting from vandalism, improper use of the built-in gas hob.

## 使用方法 OPERATION PROCEDURE

- 1、用戶在使用前，確保爐具已由註冊氣體裝置技工安裝，以策安全。
- 2、只可用標籤所指定氣體種類：  
香港石油氣 (HK LP Gas) 或香港煤氣 (HK Town Gas)
- 3、點火：  
確保旋鈕開關關到“OFF”位置，然後打開氣源總開關。點火時將旋鈕壓下向逆時針方向轉動90°，火即自動點燃，確認火已點著後即可鬆手。若火焰呈現黃焰或離焰的狀態(如圖4)，請聯絡爐具進口商跟進。請確保安裝本爐具的地方有足夠的通風。

## 售後服務 SERVICE

根據(故障原因及處理方法)項目進行檢查處理後仍不見效，或遇有不明之處時，請與代理商聯絡。電話：23001357

If these remedies (Trouble shooting) do not solve the problem, or if have any questions concerning operation or maintenance, please contact the dealer. Tel: 23001357

## 更換電池詳細圖 INSTRUCTION FOR CHANGE THE BATTERY

- 1、電池盒在爐底前方 (圖8)  
The battery box in the front of cooker bottom. (Fig.8)
- 2、打開電池盒蓋，更換電池  
Open the battery cap to change the battery.

(從爐面向下看)  
(View from the top of the built-in gas hob)

(圖8) (Fig.8)

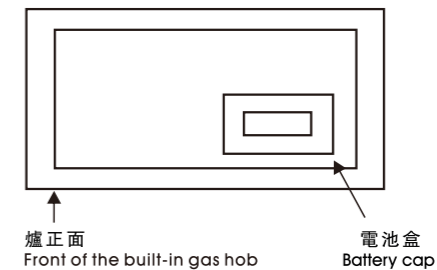

- 3、爐底與櫃底必須要有300mm以上，以便作更換電池的空間。  
The distance between the bottom of the gas cooker and the top of the cupboard should not less than 300mm, convenient to change battery for future.

注意：氣霸產品必須由我公司授權的註冊氣體裝置技工進行安裝、維修服務，否則對因安裝、維修而導致的事故，我公司概不負責。

Attention: All the installation and maintenance for the product of HIBACHI should be carried out by RGI, or HIBACHI will not be responsible for any accidents caused by incorrect installation and maintenance.

## 故障原因及處理方法 TROUBLE SHOOTING

使用中，若出現與往常不同的狀況時，請根據下列方法進行處理。若仍不見效時，請立即停止使用並與爐具進口商聯繫。

故障現象	故障原因	處理方法
點不著火	氣體接駁喉中有較多空氣	延長點火時間，直至氣體接駁喉管內空氣完全排出
	氣體接駁喉管彎折或壓扁	矯直氣體接駁喉管
	點火針髒或位置偏離	清潔並調整位置（由註冊氣體裝置技工跟進）
	噴嘴堵塞	用針狀物清除堵塞（由註冊氣體裝置技工跟進）
	大小銅蓋積水或污物	清潔
有臭味	氣體接駁喉管老化	更換氣體接駁喉管（由註冊氣體裝置技工更換）
	爐頭主火未點燃	待氣體消散後再重新點火
	閥體漏氣	更換閥體（由註冊氣體裝置技工更換）
弱火	燃氣壓力太低	檢查供氣或看減壓閥是否堵塞（由註冊氣體裝置技工調節）
	大小銅蓋堵塞	清潔
多次未能點火	機件故障	鈕回“OFF”位置，開啟窗戶加強空氣流通，吹散積存燃氣。致電爐具進口商跟進

If anything abnormal occurs during use, try the following remedies.  
If this does not rectify the problem, turn off the appliance immediately and contact the gas hob importer.

Symptoms	Cause	Remedies
No ignition	Air exist in the gas tubing	Prolong ignition time and repeatedly ignite till air goes out
	Gas hose bends	Straighten it
	Ignition plug has soot or in wrong position	Clear or adjust the position(carry out by the RGI)
	Injector clogged	Get rid of the blockage by a pin(carry out by the RGI)
	Flame holes of Burner cap are blocked by water or filth	Cleaning
Terrible smell	Gas tubing aged	Change with a new gas tubing(carry out by the RGI)
	Main fire of burner not lighted	Re-ignite after the gas dispersed
	Valve not well-sealed	Change with a new valve(carry out by the RGI)
Weak flame	Gas pressure too low	Check gas supply or whether gas regulator is clogged(carry out by the RGI)
	Ports of burner cap clogged	Clean ports
No ignition repeatedly	Parts failure	Turn the flame controller knob to "OFF" and open window to enhance ventilation and remove unburnt gas. Please contact the gas hob importer to follow

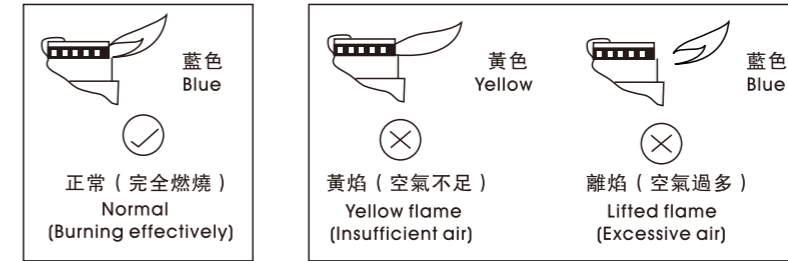

(圖3)(Fig.3)

(圖4)(Fig.4)

- 火力調節  
按照各旋鈕所對應的火力大小指示，旋轉旋鈕，即可獲得所需火力。除“大火”至“小火”可調教火力外，由“大火”至“關”亦可調較火力大小，切換猛火與小火，須慢慢旋轉點火旋鈕，以保證不致熄火（如圖5）。
- 熄火  
將旋鈕回轉到“關”的位置，火即熄滅（如圖5）。使用後必須關閉氣源總開關（總閥）。
- 點不著火  
將旋鈕回轉到“關”的位置及待氣體消散後，可參閱“故障原因及處理方法”或致電進口商派遣註冊氣體裝置技工跟進。

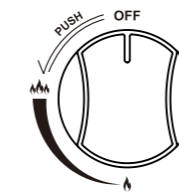

(圖5)(Fig.5)

HY-9229

OFF	關	Off
🔥	大火	High
🔥	小火	Low

- User should check that this built-in gas hob has been properly installed by Registered Gas Installer.
- This built-in gas hob is suitable for use with the specified type of gas(HK LP Gas or HK Town Gas).
- Ignition:  
Make sure the flame controller knob at "OFF" position, then open the gas supply valve. When igniting, press and turn the flame controller knob anti-clockwise to 90 degree, the built-in gas hob will be automatically ignited. After ensuring the flame, the knob can be released and flame will retain. If flame show as a yellow flame or lifted flame(Fig.4). Please contact the gas hob importer to follow. Ensure that installation location is well ventilated.
- Flame regulating  
Different size of flame can be obtained by regulating the flame controller knob. As (Fig.5) the power can adjust between "High" and "Low", and also can adjust from "High" to "OFF", please adjust the flame slowly from high to low, to avoid the flame off.
- Extinguish the flame  
Return the flame controller knob to "OFF" position will extinguish the flame(Fig.5). Please close the gas supply valve after use.
- No ignition  
Return the flame controller knob to "OFF" position and wait until gas dispersed. Please read "Troubleshooting" or contact the gas hob importer follow up by the RGI.

### 安全裝置 FLAME FAILURE PROTECTION DEVICE

此安全裝置只防止因風或水等意外使爐火熄滅所引起的漏氣事故，不能防止其它原因所致的漏氣事故。氣體將在10-30秒內關閉。安全裝置啟動後也必需將旋鈕盡快轉回到關“OFF”的位置，待氣體消散後才可重新點火。請勿過於依賴安全裝置，請小心使用氣體爐具。

This safety device can protect accidental extinguish of flame due to wind or water but it cannot protect all kinds of gas leakage conditions. The gas valve will close in 10-30 seconds. Adjust the flame controller to "OFF" as soon as possible even the flame failure protection device is functioned. And re-ignite after the gas dispersed. Please do not totally rely on the flame failure protection device.

## 防乾燒功能 (只適用於左爐頭)

## ANTI-SCORCH FUNCTION (LEFT BURNER ONLY)

- 當食物燒焦，溫度感應器探測到鍋具高溫時，爐火會自動熄滅，蜂鳴器同時發出20秒響聲。  
When foods are scorched, the high temperature of the pot is detected by the temperature sensor. Thus, the flame is turned off automatically, and the buzzer sounds for 20 seconds.
- 當加熱水分少的食物時，建議先加水並使用中或小火烹調，以避免中途熄火。  
When cooking low water content foods, add water and cook with medium or weakest flame to avoid flame off halfway.
- 請遵守下列指示使用防乾燒爐頭：  
為確保防乾燒爐頭正常運作，請使用金屬鍋具，並確定鍋底與溫度感應器之間沒有間隙異物。不要使用底部不平、複合底、圓底、陶瓷或玻璃鍋，以免中途熄火。(如圖6)  
Follow the following instructions to use the anti-scorch burner:  
To ensure regular operation of the anti-scorch burner, please use a metal pot, and ensure that there is no gap or foreign object between the pot bottom and the temperature sensor. Do not use the pot with a rugged, multilayer, or round bottom or made of ceramic or glass materials to avoid flame off halfway.(Fig.6)

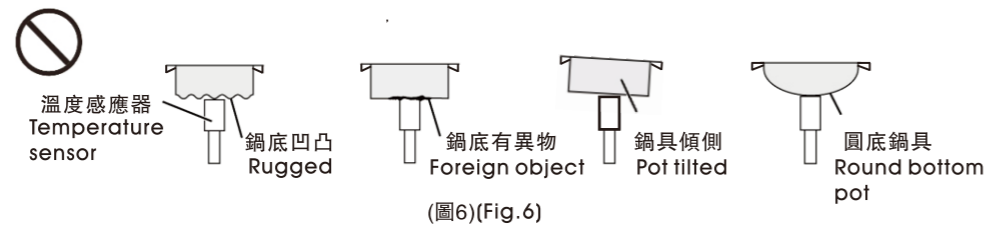

- 使用大火煎炒或油炸食物時，有機會因高溫而啟動防乾燒功能，如問題持續發生，請使用沒有防乾燒功能的爐頭繼續烹調。  
When stir-frying or deep-frying food with the strongest flame, high temperature may trigger the anti-scorch function. Use another burner without an anti-scorch function to continue cooking if the problem persists.
- 即使配備防乾燒功能，因應不同食物特質，也可能出現燒焦及黏底的情況。建議使用小火烹調易燒焦的食物。  
Even equipped with an anti-scorch function, food may be scorched or stuck on the pot bottom depending on food properties. When cooking food that is scorched easily, it is recommended to use the weakest flame.

## 日常檢查、清理 DAILY CHECKING AND HOUSEKEEPING

### 1、檢查清理時請注意事項

- 檢查清理之前必須關閉氣體總開關等待器具冷卻後進行。

### 2、檢查項目

- 接駁喉管是否燒壞、腐蝕、老化，致使燃氣外漏。
- 爐具附近是否有易燃物（如油、紙、布、木等等）。
- 銅蓋火孔是否被油和積物堵塞。
- 將大銅蓋及小銅蓋正確裝於爐頭上。
- 關於檢查清理，除上述日常檢查以外事項，請委託經銷商處理。

可取出清潔的部件 Clean parts can be removed

- 大銅蓋 Large Burner Cap
- 小銅蓋 Inner Burner Cap
- 爐碟 Drip Plate
- 爐架 Trivet

可清潔的部件 Cleanable part

- 玻璃面 Top Panel
- 旋鈕 Flame Controller Knob

清潔後請將取出的部件放回原位  
(詳細內容請看P8)

Put the removed parts back in place after cleaning(Detail on P8)

### 3、保養

- 爐具表面保養：先以中性洗潔劑擦拭後，再以乾布擦拭。
- 爐頭保養：為使爐具保持正常使用與良好燃燒狀態，請經常地取出大小銅蓋以銅刷清除銅蓋各齒間物，切勿用水洗。

- 請確保旋鈕、爐蓋及爐架安裝正確。安裝不正確將嚴重影響產品的正常使用並縮短爐具的使用壽命。安裝爐架及爐頭時，請留意爐架及爐頭底部的突出物與面板上的伸展槽匹配。如安裝不正確致火焰不均或回火，導致火焰不完全燃燒，有機會導致一氧化碳中毒！(如圖7)



### 1. Items to note when checking

- Please ensure the gas valve is closed and the built-in gas hob has cooled down before checking the built-in gas hob.

### 2. Checking items

- Is the gas tubing any signs of being burned, corroded, aging that will lead to gas leakage.
- Is there any combustible material near the built-in gas hob(e.g.oil, paper, timber, cloth, etc).
- Is the ports on the burner cap being blocked by oil and filth.
- Are the large, inner burner cap being properly located.
- Apart from above, please contact local agent to send technician to check the built-in gas hob.

### 3. Maintenance

- To maintain the surface of the built-in gas hob: Use mild detergent to clean, then use dry cloth to finish the cleaning.
- Burner maintenance: Please regularly brush the large and inner burner cap to remove debris and loose material to ensure the burning is always kept in perfect condition. Please do not use water to clean.

- Please make sure that the flame controller knobs, burner caps, drip plate and trivet have been installed correctly. Incorrect installation will seriously affect the normal use of the product and shorten its life-span. When installing the trivet and burner caps, user should pay attention that the protruding objects on the bottom of the trivet and burner caps are aligned with the stretching slot on the top panel. Incorrect installation might cause flame becomes unstable or if there is the occurrence of a flashback, which leads to incomplete combustion, this may cause carbon monoxide poisoning!(Fig.7)

## 規格參數 SPECIFICATIONS

Model 型號	HY-9229	
Overall Dimensions 爐身尺寸	Width(mm) 寬度(毫米)	750
	Depth(mm) 深度(毫米)	450
	Height(mm) 高度(毫米)	160
Surface 爐面	Tempered Glass 強化玻璃	
Weight 重量	15.2kg	
Gas Type 氣體種類	HK Town Gas 香港煤氣	
Gas Pressure 氣體壓力	1500(Pa)	
Rated heat input 額定熱負荷	Left 左: 6.0kW Right 右: 6.0kW	
Ignition System 點火方式	Impulse Ignition System 脈衝點火方式	